

The image shows a detailed architectural floor plan of a cohousing unit. The unit is L-shaped, with a central courtyard area. The courtyard is a large circle divided into several segments, with a person and a dog walking in it. There are trees and clouds around the courtyard. The unit includes a kitchen, a living area with a table and chairs, a bedroom, and a bathroom. There are also some storage areas and a shared storage area. The plan is drawn in a simple, line-art style with some grey shading for walls and furniture. A yellow box is overlaid on the top right of the plan, containing the title and subtitle. The bottom right of the page contains the names of the participating cities and the lead researcher.

Cohousing for Ageing Well: a collaborative design research project

**Public Consultation Submission in response to
South Australia's new Planning and Design Code
February 2020**

**The City of Unley
The City of Burnside
The Town of Walkerville
The City of Prospect
Dr Damian Madigan**

Our State has the highest proportion of older people in mainland Australia; **over a third of all South Australians are aged 50+ and nearly 8% of us are over the age of 75**. However, Australia-wide only 5% of older people live in care accommodation, although 19% of older Australians are or have been carers themselves. Significantly, **20% of older Australians report experiencing loneliness**.¹

In this context, the concept of '**Ageing in Place**' becomes significant. Beyond the undertaking of home modifications to enhance access and mobility, it means providing housing choice and flexible housing options to enable people to continue to live **independently** in their own home or in a new home within a community in which they feel **comfortable, secure** and **familiar**.

Cohousing is one means by which a group of older residents might come together to create a community-focused residential development where they downsize to something smaller while retaining much of the amenity offered by the traditional single-family home. It is also a potential housing form for all ages, through an **assisted living** model, **multi-generational living**, improved **entry into the housing market**, and an increase in more **affordable rental supply**. Proposed for suburbs that are well-connected to existing services and social supports, the housing model discussed in this submission can serve as a model for **good infill housing for all ages**.

Background to this submission

In 2019/20, a partnership investigating cohousing for ageing in place, focusing on new opportunities for existing housing, has brought together:

- The City of Unley (Project Coordinator)
- The City of Burnside
- The Town of Walkerville
- The City of Prospect
- Office for Ageing Well (SA Health)
- South Australian State Planning Commission
- Department of Planning, Transport and Infrastructure (DPTI), and
- University of South Australia School of Art, Architecture and Design (UniSA).

At the time of making this submission, the research project is live, with completion due by 30 June 2020.

Principally funded by Office for Ageing Well under its 2019 Age Friendly SA Grants program, the project has received support funding from the State Planning Commission, via DPTI, and from each of the four Councils. The project is an extension of alternative infill and so-called 'missing middle' housing research undertaken by Dr Damian Madigan, Senior Lecturer in Architecture at UniSA. Dr Madigan is the Chief Investigator for this project and the author of the Missing Middle Case Study commissioned by DPTI for its People and Neighbourhoods Discussion Paper (December 2019). The four draft design schemes provided in Appendix A of this submission are the development of that Case Study's key concepts.

Although the State Planning Commission, DPTI, Office for Ageing Well and UniSA are partners in this project, the 'Cohousing Project Group' making this submission on the Draft Code are the City of Unley, the City of Burnside, the City of Prospect, the Town of Walkerville and Dr Damian Madigan.

Enquiries about this submission can be directed to:

Dr Damian Madigan
Senior Lecturer in Architecture
University of South Australia
GPO Box 2471, Adelaide SA 5001
tel: (08) 8302 0703
email: damian.madigan@unisa.edu.au

¹ The Australian Centre for Social Innovation, Vision for Ageing Well in South Australia, prepared for Office for Ageing Well, November 2019.

Recommendation for The Code

The Cohousing Project Group recommends that there be recognition and support for Cohousing initiatives within the Planning and Design Code (The Code). In accordance with the 30 Year Plan for Greater Adelaide and the People and Neighbourhoods Policy Discussion Paper, more housing choice is needed to increase housing supply and diversity across ages and to reflect emerging trends of ageing well in place, by providing affordable ways to enter the housing market and encouraging the downsizing of accommodation as a response to life cycle and household changes. Coupled with these factors is the desired retention of neighbourhood character and resident and community buy-in within a changing urban landscape.

Cohousing defined and the limits of the study

Cohousing is commonly conceived of as a collection of independent dwellings on a large site, with a shared Common House providing large spaces for shared cooking, eating, socialising and hobbies. These shared spaces allow – and indeed encourage – residents to come together when they wish to socialise, and to retreat to their own self-contained dwellings on the site when they prefer their privacy. Significantly, shared spaces allow each independent dwelling to be small, unlocking the potential for sensitive density increases. A kitchen, for example, can be designed as small as a kitchenette, with the large Common House kitchen providing the space and utility that might otherwise be missing in each private dwelling. Similarly, the provision of a large Common House laundry with multiple washing machines means that individual laundries can be either removed completely from the individual dwellings or replaced in the bathrooms or kitchenettes with small-footprint or portable washing machines for day-to-day smaller items. Importantly, it is the shared facilities that give residents a reason to step out of their dwellings, thereby encouraging both formal and incidental engagement with neighbours when such opportunities might otherwise be lost.

A guest room provided in the Common House can double as a shared study or hobby space whilst also providing residents with a spare bedroom on an as-needs or rostered-use basis. In addition to providing space for holiday or overnight visitors, this room is useful for temporary live-in carers who might be required, for example, when a resident is recuperating at home following a hospital stay.

It is common for cohousing developments overseas to have from 15 to 25 dwellings. For the purposes of this project 'cohousing' is a scaled-down version of this model, where small-footprint dwellings are designed around a shared garden on a single residential allotment. Four draft designs for inner-Adelaide are included here for reference in Appendix A. Three of the designs contain some form of Common House, while the fourth does not. In this fourth instance, 'cohousing' occurs only through sharing the garden, car parking and movement through the site.

It can be assumed that as this new housing model develops and case studies are built, there will be degrees of sharing based on the needs of the residents. It is not suggested that this is a housing model for everyone, and it can be anticipated that each new cohousing development will be as individual as those who create it.

This Cohousing for Ageing Well project is primarily concerned with investigating the appetite for this innovative housing model amongst residents and key stakeholders. It is not investigating viability related to financing, land titling or profitability. The development of a new housing typology is complex, with varied competing factors. Whilst such factors lie outside the scope of this project, they are understood to be important and will be subject to future research.

An alternative to knock-down-rebuild in our older suburbs

This collaborative design research project is concerned with how much-needed density increases can be achieved sensitively in our older suburbs whilst at the same time increasing the diversity of our housing stock, providing increased opportunities for social inclusion, and retaining and enhancing neighbourhood character.

This includes retaining mature landscape, where possible, and providing enough open space to allow deep-root plant zones to be created in order to encourage large tree canopies.

The project is looking at alternatives to knock-down-rebuild (KDR) infill development, exploring instead how existing older houses in Adelaide might be altered and extended in familiar ways in order to create one or more additional dwellings on an existing site. Rather than altering and extending dwellings to make single houses larger, the ambition is to create small-footprint houses for older residents wishing to age in place and in a more socially connected manner.

Additionally, the Project Group believes that the design of well-considered small-scale infill housing that seeks to retain the character of existing suburbs while serving the needs of older people can inform new infill housing models for the broader population.

This project, significant in its scope and broad in its application is exploring for the first time a major gap in housing opportunities for Adelaide's existing suburbs.

By examining options and potential for cohousing across standard house types and block sizes, a key outcome of this study is to demonstrate planning and design strategies, and disseminate project findings to key stakeholders including the community, the housing industry, local councils, Elected Members, and the State Planning Commission.

Older residents from the four council areas have participated in a co-design workshop to provide input to inform the development of the four detailed cohousing design studies. These studies, currently in draft form and due to undergo further development, are included in this submission in Appendix A in order to illustrate the principles being developed.

What follows is a range of comments on the Draft Code, written to suggest ways in which this new 'Cohousing Accommodation' dwelling form might be introduced to South Australia's new planning system.

Comments on the Draft Code:

The Project Group recommends the following comments be inserted into The Code:

Insert in Part 7 – Land Use Definitions

A new housing definition is needed that sits outside current land use definitions for dwellings and accommodation and is referred to as 'Cohousing Accommodation'.

Cohousing Accommodation means accommodation that:

- *Is located on the same allotment as an existing dwelling;*
- *Retains the existing dwelling (as viewed from the primary street and, in the case of a corner allotment, secondary street);*
- *Shares facilities with other accommodation on the same allotment; and*
- *Is not subordinate to the existing dwelling and co-exists as an equal entity(s).*

Insert into all Residential Neighbourhood Zones (General, Housing Diversity and Suburban) the following:

- The term 'Cohousing Accommodation' should be applied to all the residential zones as an envisaged use and be inserted into the DTS/DPF which states *'residential development comprises: . . . cohousing accommodation'*
[refer to General Neighbourhood and Housing Diversity Neighbourhood Zones DTS 1.2]
- Insert 'Cohousing Accommodation' as a new sub-heading and provide the following policy support:

Cohousing accommodation

Cohousing accommodation comprises development that:

- *Is situated on the same allotment as the existing dwelling and requires a land management agreement (or similar) to be entered into to maintain this relationship;*
- *Provides site density dispensation, while maintaining site coverage and technical numerical variations in accordance with zone requirements;*
- *Retains and incorporates the existing dwelling in association with other accommodation that is not subordinate to the existing dwelling;*
- *Includes shared facilities (eg. common internal spaces) and utilities (eg. water, electricity, gas, sewer);*
- *Reconsiders private open space in favour of consolidated areas of shared open space;*
- *Is designed to contribute to local context and is fit-for-purpose within the site (eg. resolves private and communal areas and pedestrian and vehicle movement) and includes a recognised design review of the development as part of the pre-lodgement process;*
- *Retains mature landscaping and/or provision of deep soil space and provides additional landscaping treatments to soften the appearance and provide 'green leafy' views from the street and to adjoining properties; and*
- *Provides car parking (including the consideration of reduced and zero car parking requirements) using a flexible formula, relative to the nature of the development, its degrees of sharing, and demonstrated need.*
[note: this requirement would be required to be added to Table 1 – General Off-Street Car Parking Requirements under 'Transport, Access and Parking'].

Cohousing for Ageing Well: four design studies

The four design studies that follow are being developed in the project. As such they are offered in draft form. The drawings are best printed on A3 paper without scaling.

The project methodology is to test what might be considered four typical sites across the four Council areas: Unley, Burnside, Walkerville and Prospect. The sites are presented as Small (~325m²), Medium (~530m²), Large (~675m²) and Extra Large (~920m²). Two of the sites have rear lanes, one is a corner allotment and the fourth is land-locked, with a single entry off the street.

The design studies have been prepared in consideration of the following issues and assumptions:

- A whole-of-site approach is taken, where multiple dwellings access large high-amenity shared open space through a process of alterations and additions rather than wholesale demolition.
- The model is based upon the principles of:
 - no land division;
 - no wholesale demolition of the existing house on a site, but rather its judicious retention, alteration and extension;
 - a reconsideration of Private Open Space in favour of larger areas of shared space;
 - permitted overlooking within the allotment, with the maintenance of existing privacy mechanisms for adjacent neighbouring properties;
 - newly created dwellings not being subordinate to the existing dwelling, but rather creating a flat hierarchy of dwellings sharing the one site; and
 - a Land Management Agreement supporting the design model being enacted, to ensure no future subdivision or liquidating of dwelling units into isolated entities.
- A Performance-Assessed Development model is proposed, with specific policy requirements / Performance Criteria around such areas as:
 - the retention and reuse of existing housing stock;
 - the demonstrated maintenance of or improvement to streetscape and local character;
 - the retention of mature landscape and/or the provision of deep root plant zones and a commitment to tree planting as part of the development;
 - demonstrated site usage design, including landscape design, to demonstrate site functionality, pedestrian and vehicular movement, and degrees of privacy between dwellings;
 - demonstrated accommodation of rubbish/waste management, including rubbish bin locations and kerb access; and
 - reconsidered car parking provisions based on demonstrated needs, including consideration of reduced or zero parking requirements where a case can be successfully made.
- Incentivising applicants with, for example, increased density allowances and/or reduced car parking requirements, relative to the proposal's demonstrated maintenance and/or enhancement of streetscape and landscape character, demonstrated housing diversity supply, etc.
- The ability for all existing housing to be used as a model, regardless of heritage status, age or typology (noting that those existing houses shown in the four examples are villas and cottages).
- No minimum site requirements, with the onus put on the applicant to demonstrate suitability.
- Assessment via a Prescribed Body such as a Design Review Panel.

Together, the four design studies represent typical conditions of size, site access and existing use. While they are common to the four council areas involved in the project, the learnings can be applied across greater Adelaide and beyond.

S
325m²

31
dw/ha net

64%
site cover

SMALL SITE: **business as usual** site layout

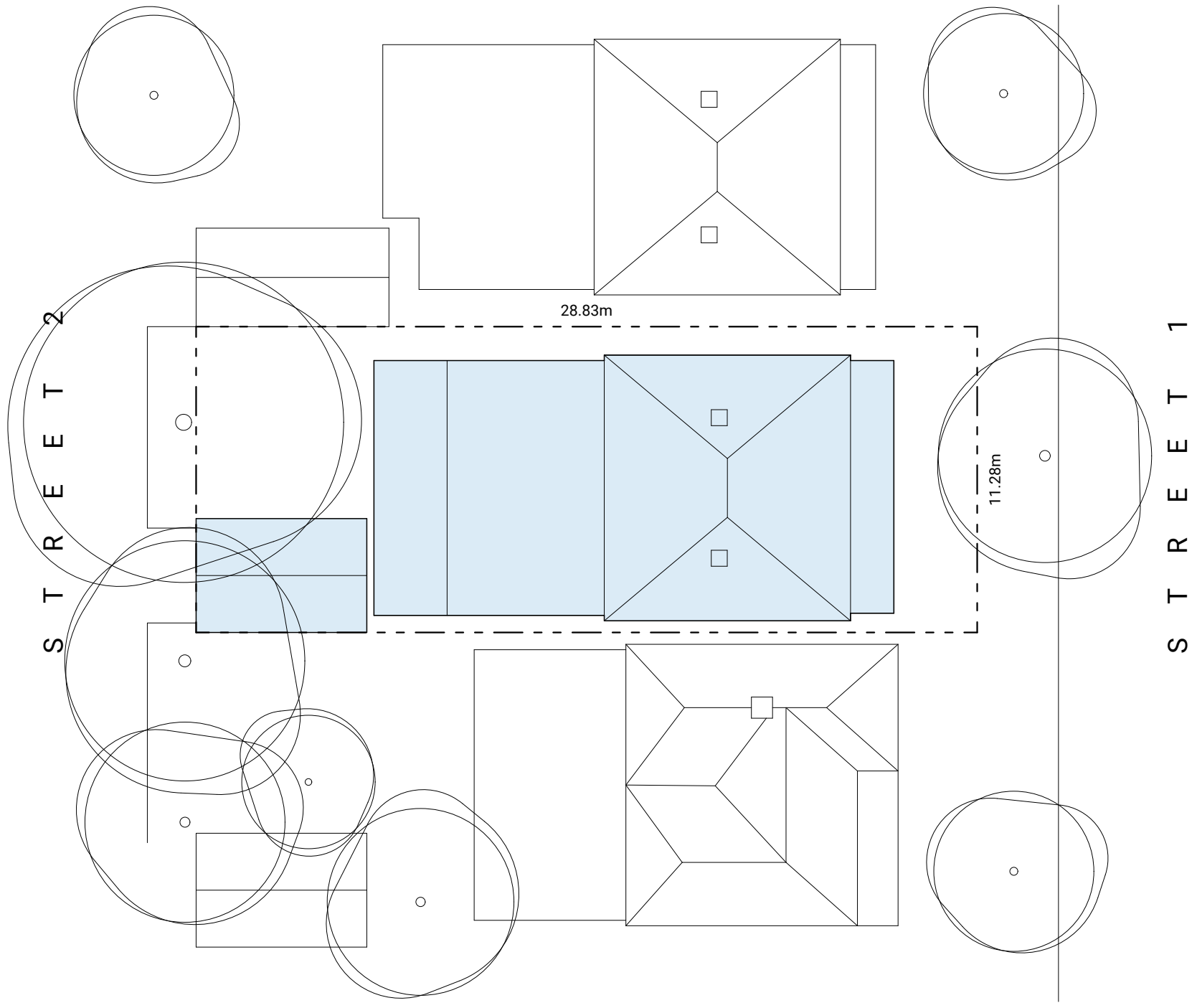
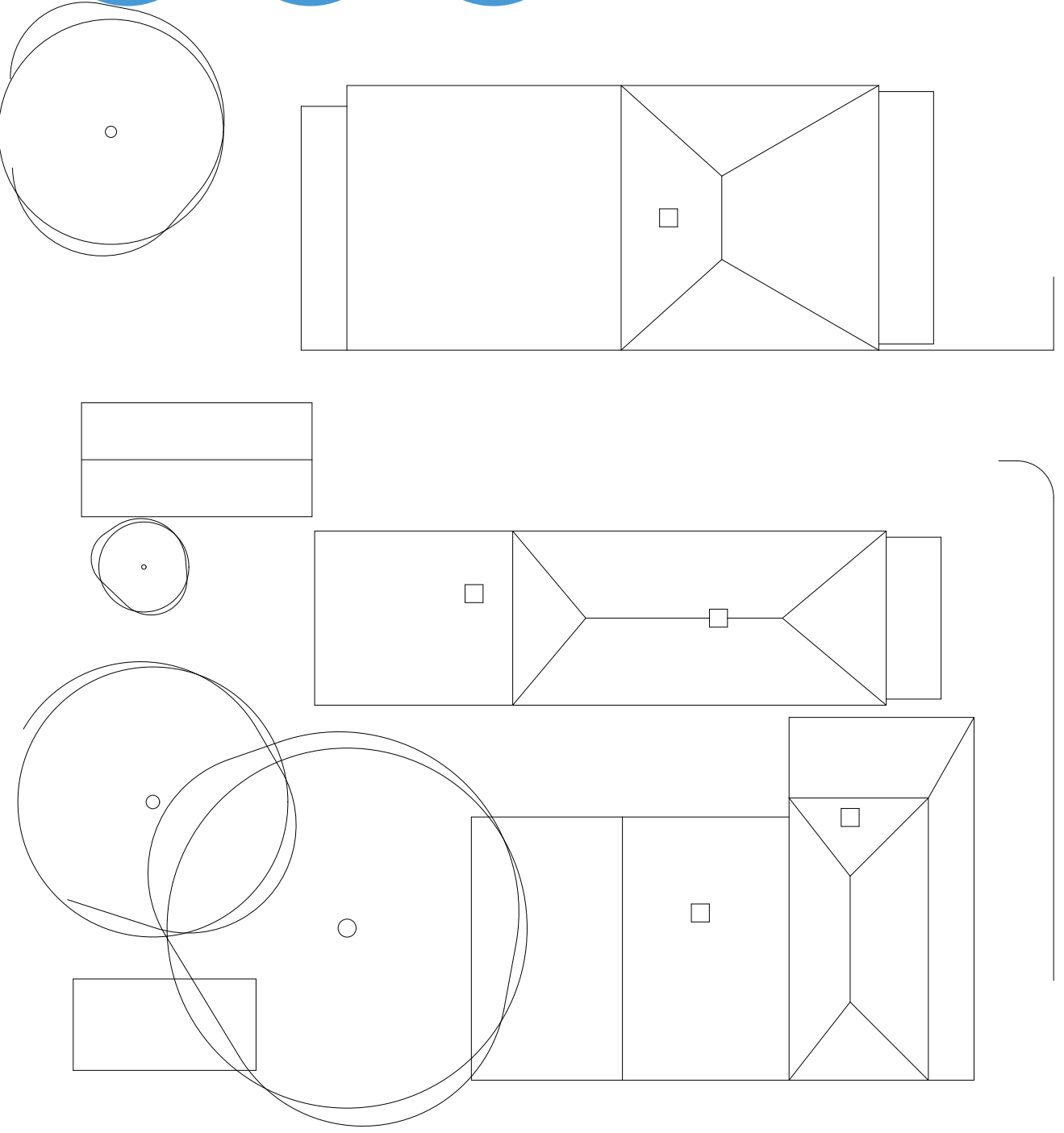

S
325m²

31
dw/ha net

64%
site cover

62
dw/ha net

59%
site cover

SMALL SITE: potential **cohousing accommodation** site layout

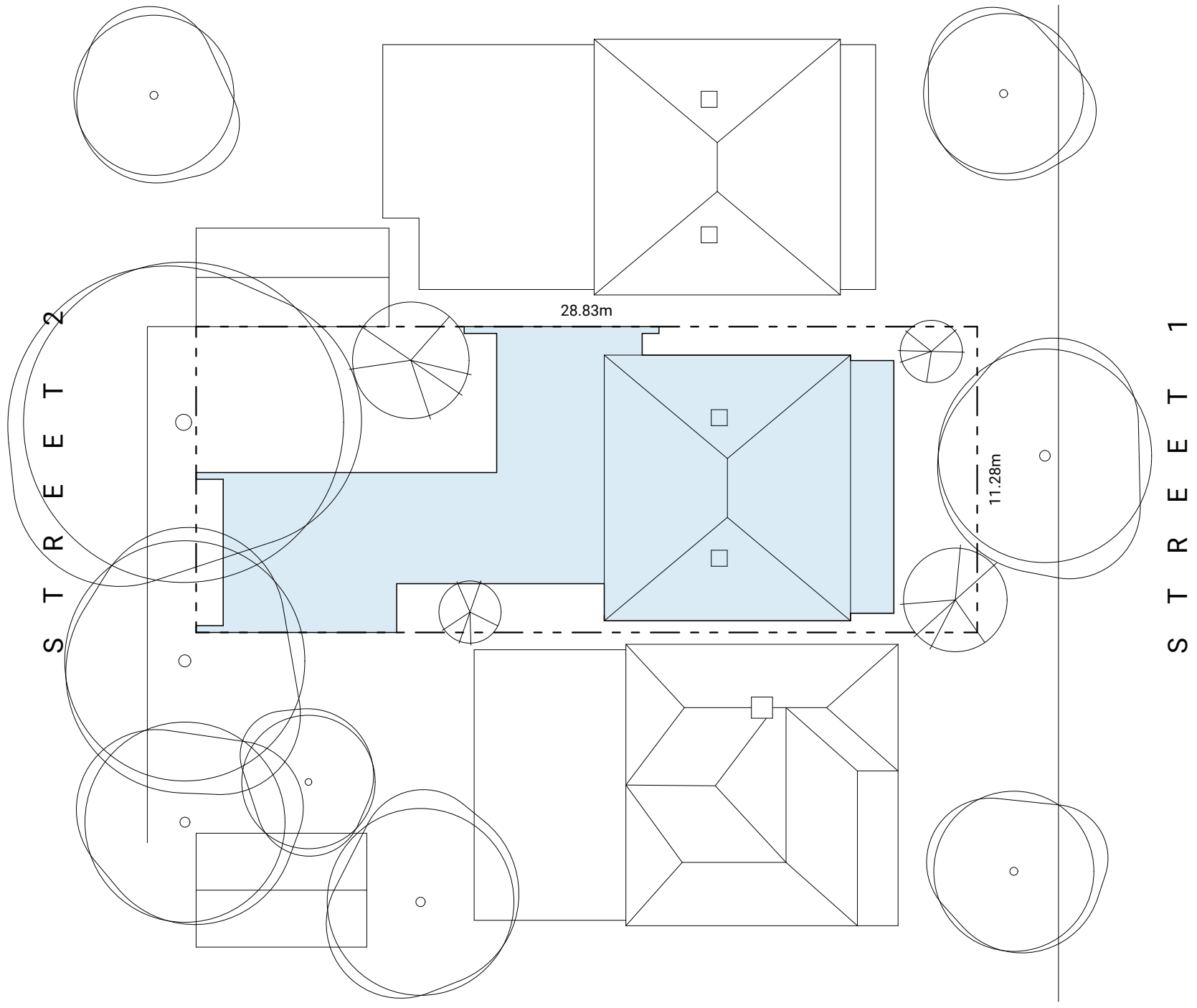
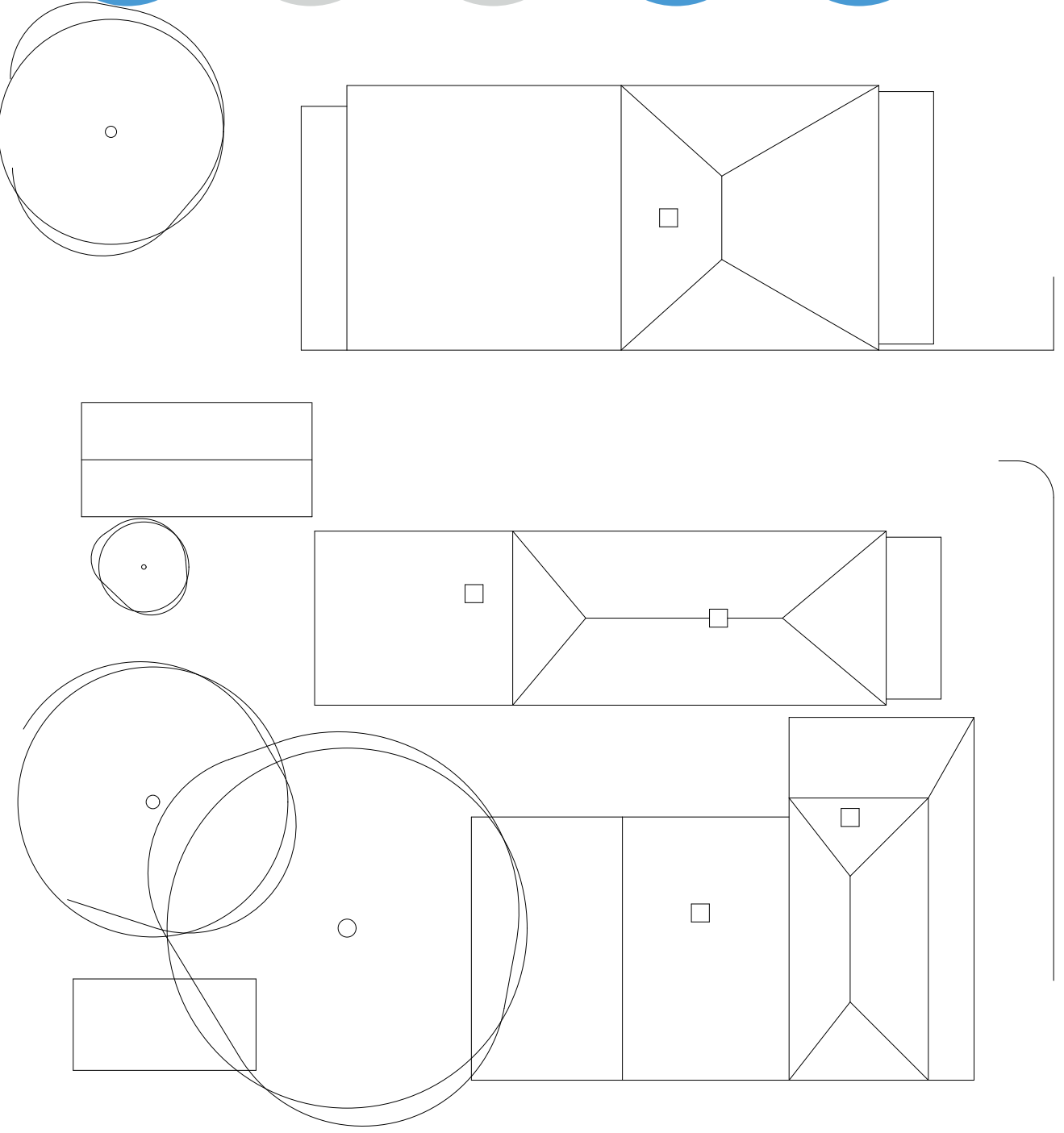

S
325m²

31
dw/ha net

64%
site cover

SMALL SITE: **business as usual** floor plan

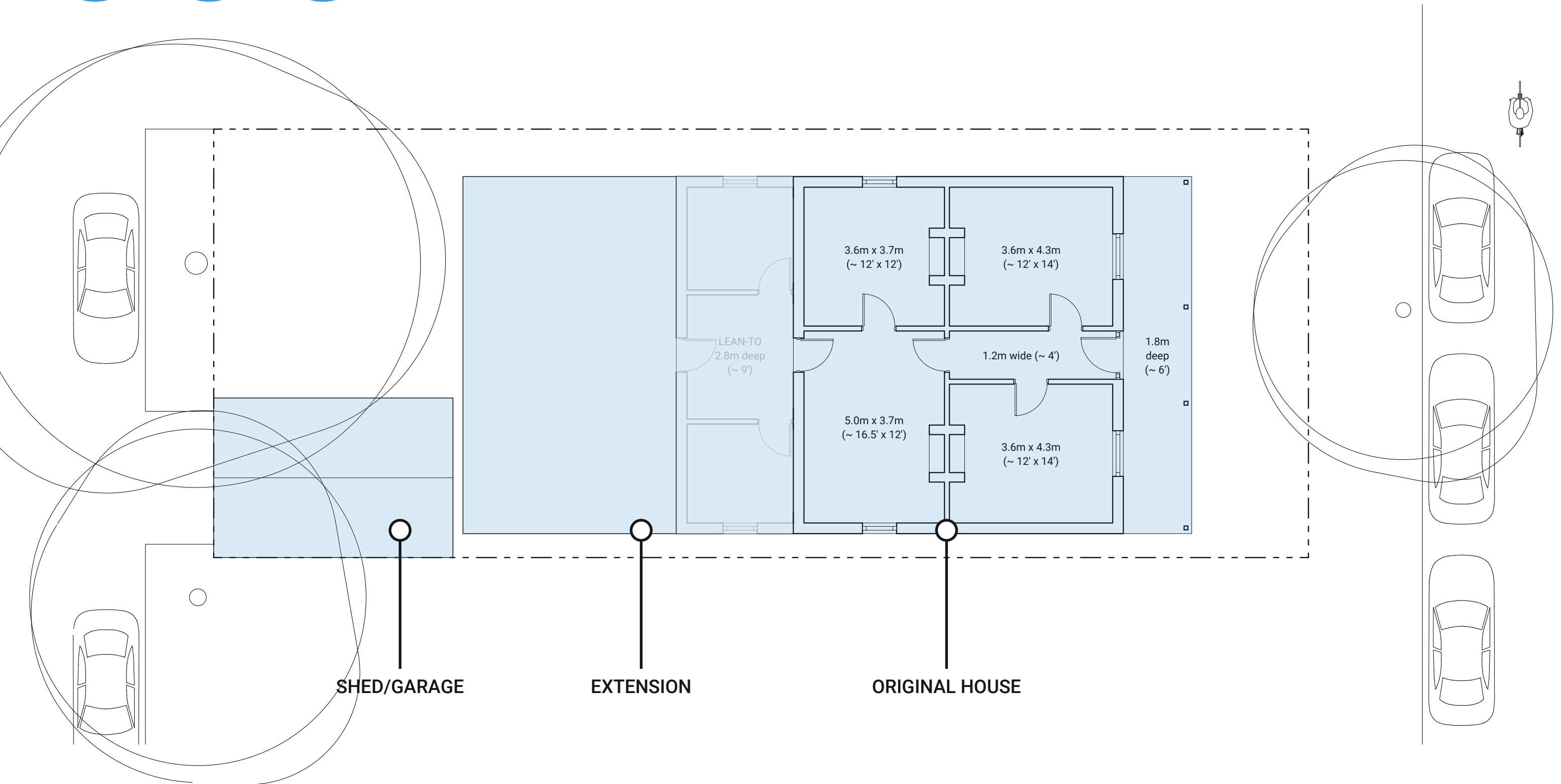

S
325m²

31
dw/ha net

64%
site cover

62
dw/ha net

59%
site cover

SMALL SITE: potential **cohousing accommodation** floor plan

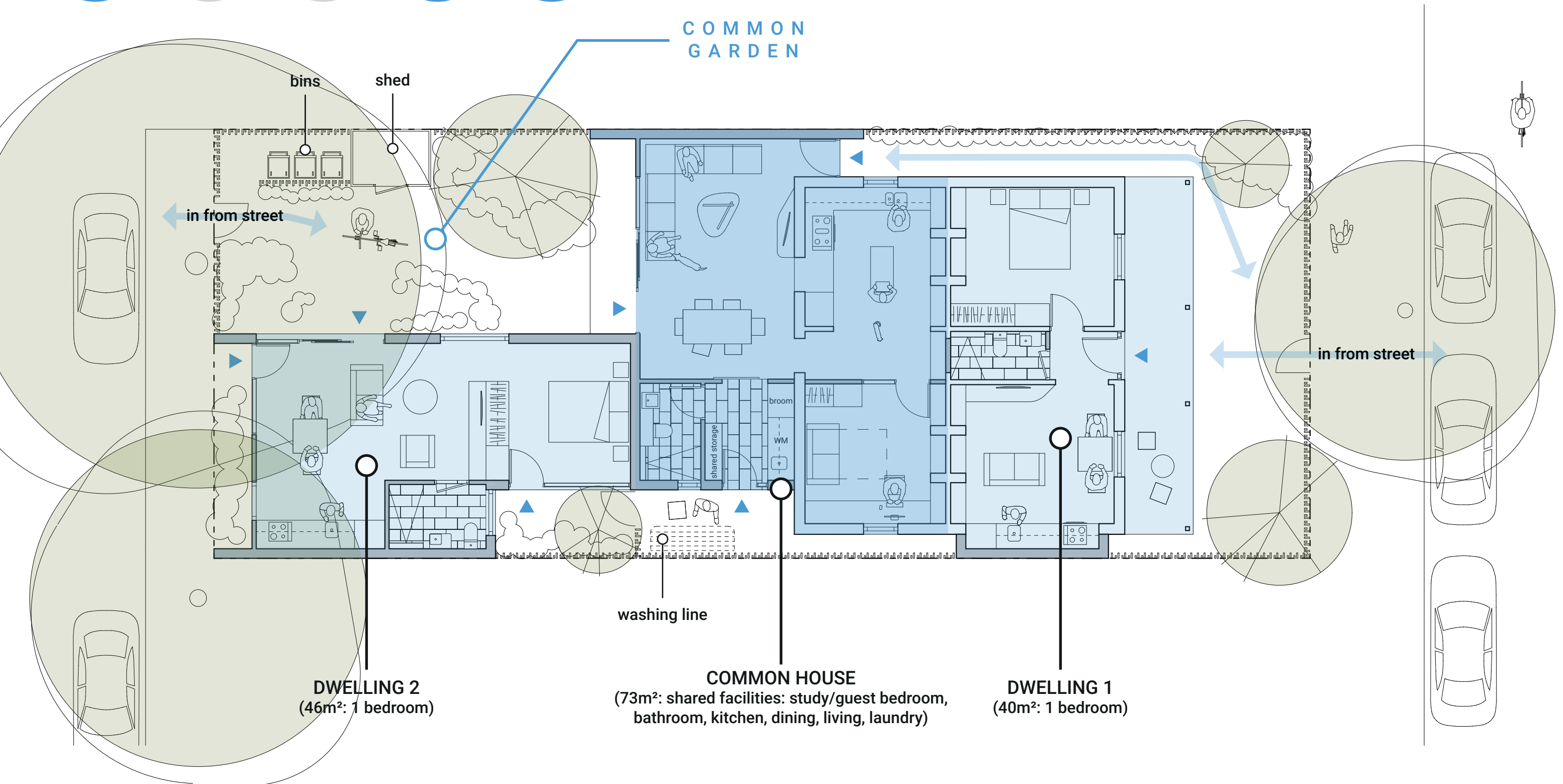

M
530m²

19
dw/ha net

47%
site cover

MEDIUM SITE: **business as usual** site layout

S
T
R
E
E
T

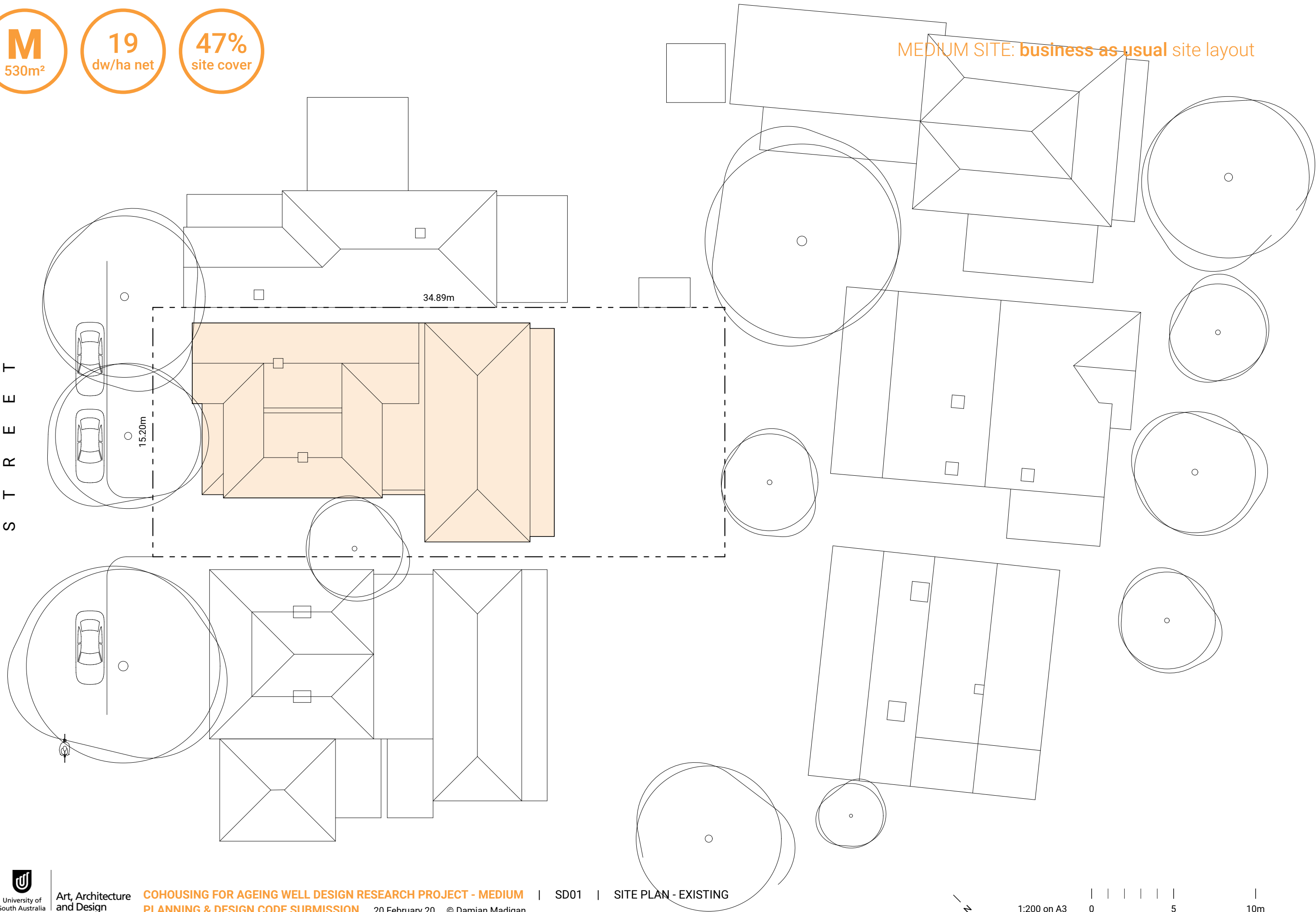

34.89m

15.20m

M
530m²

19
dw/ha net

47%
site cover

38
dw/ha net

45%
site cover

MEDIUM SITE: potential **cohousing accommodation** site layout

S
T
R
E
E
T

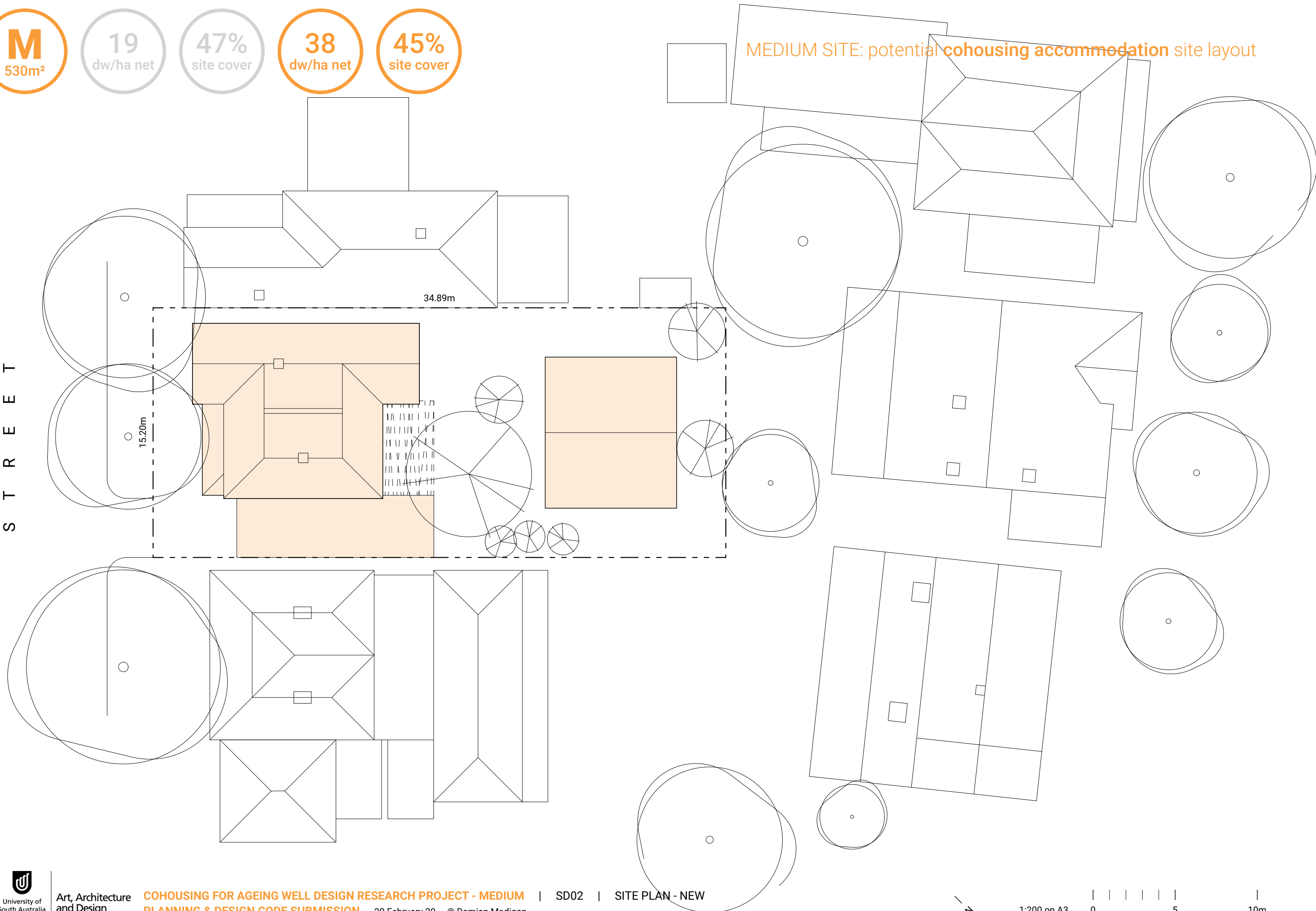

M
530m²

19
dw/ha net

47%
site cover

MEDIUM SITE: **business as usual** floor plan

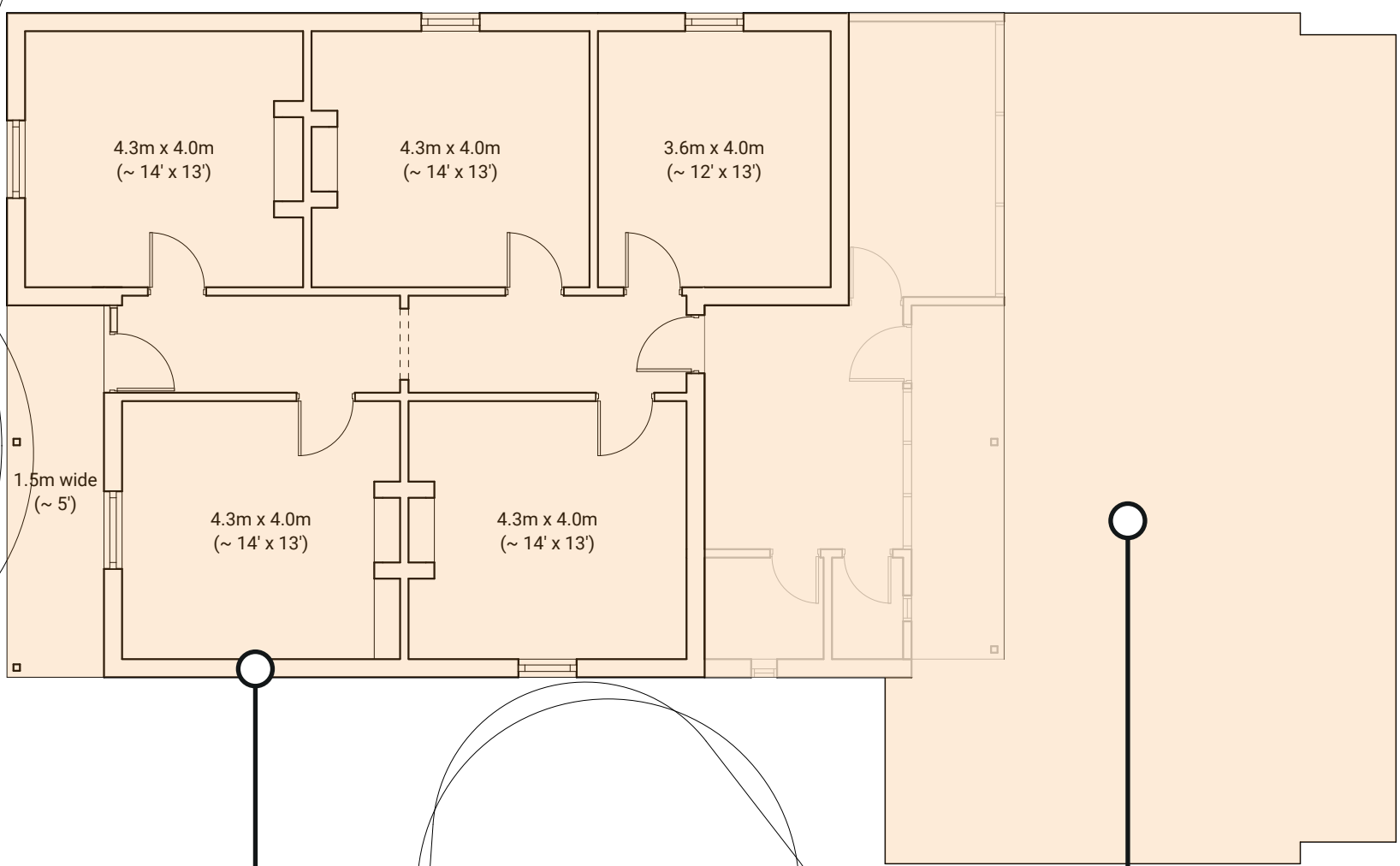

ORIGINAL HOUSE

EXTENSION



M
530m²

19
dw/ha net

47%
site cover

38
dw/ha net

45%
site cover

MEDIUM SITE: potential **cohousing accommodation** floor plan, ground floor

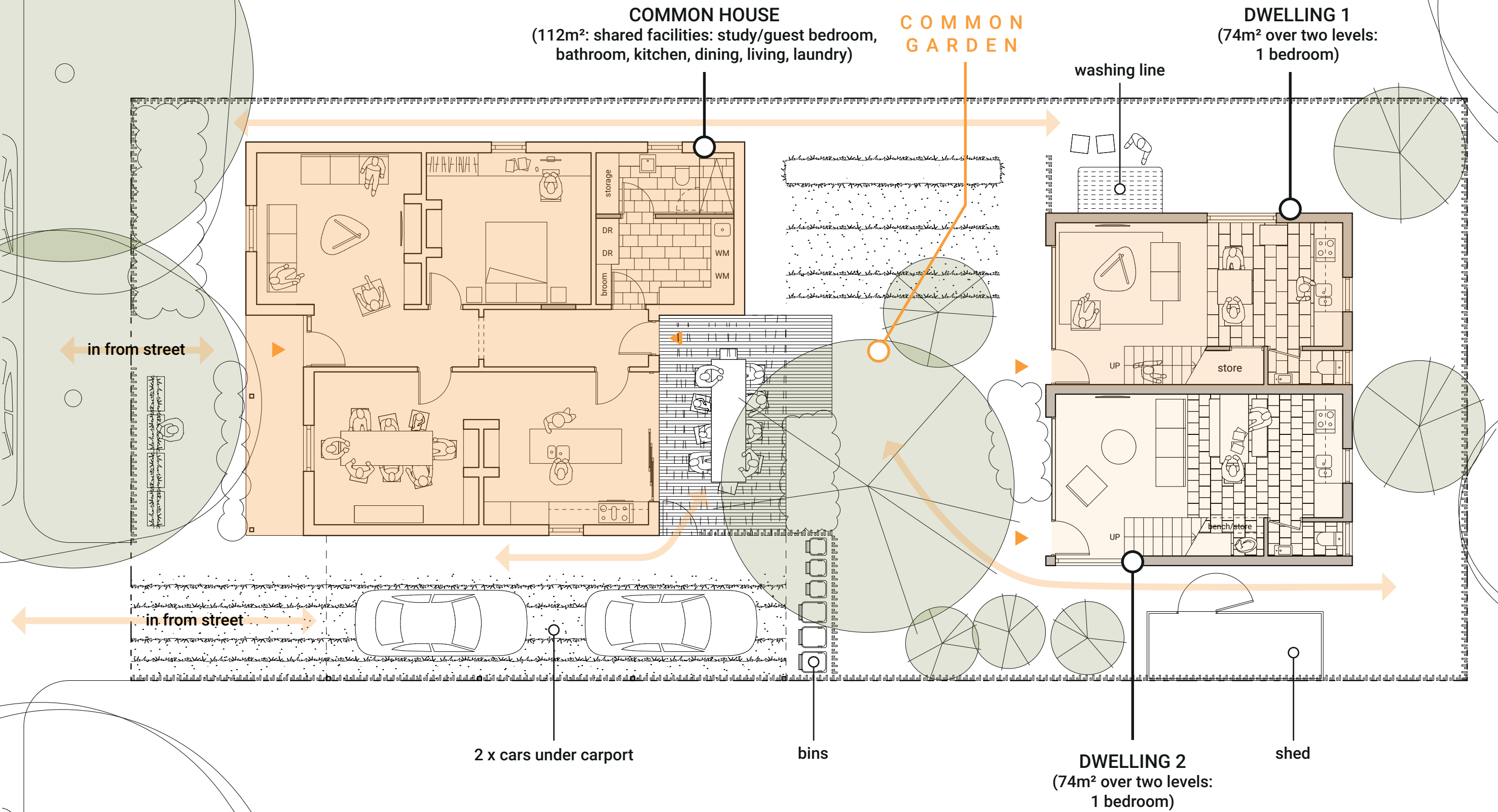

M
530m²

19
dw/ha net

47%
site cover

38
dw/ha net

45%
site cover

MEDIUM SITE: potential **cohousing accommodation** floor plan, first floor

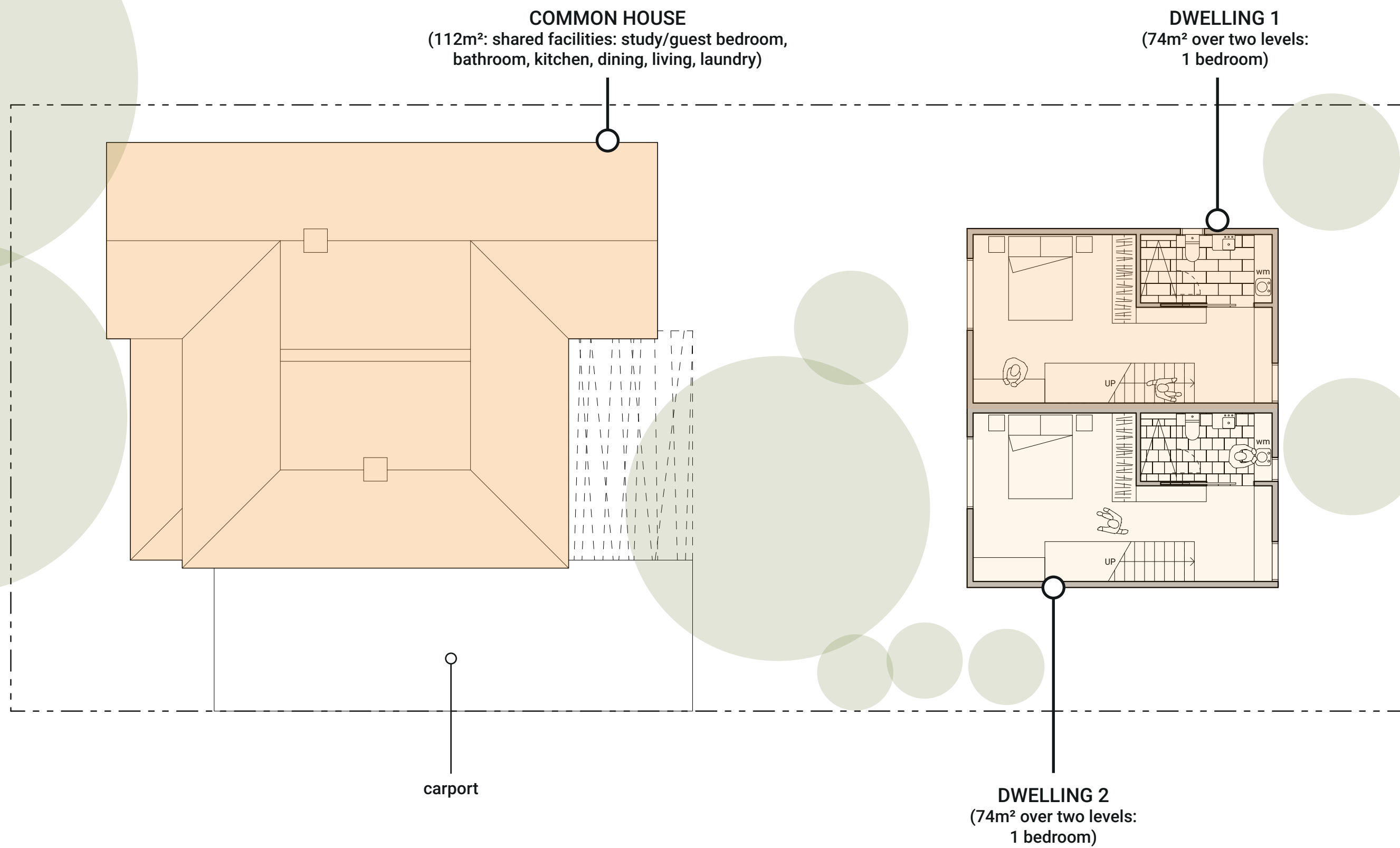

L
675m²

15
dw/ha net

48%
site cover

LARGE SITE: **business as usual** site layout

S T R E E T 2

S T R E E T 1

41.00m

16.46m

L
675m²

15
dw/ha net

48%
site cover

45
dw/ha net

37%
site cover

LARGE SITE: potential **cohousing accommodation** site layout

S T R E E T 2

S T R E E T 1

16.46m

41.00m

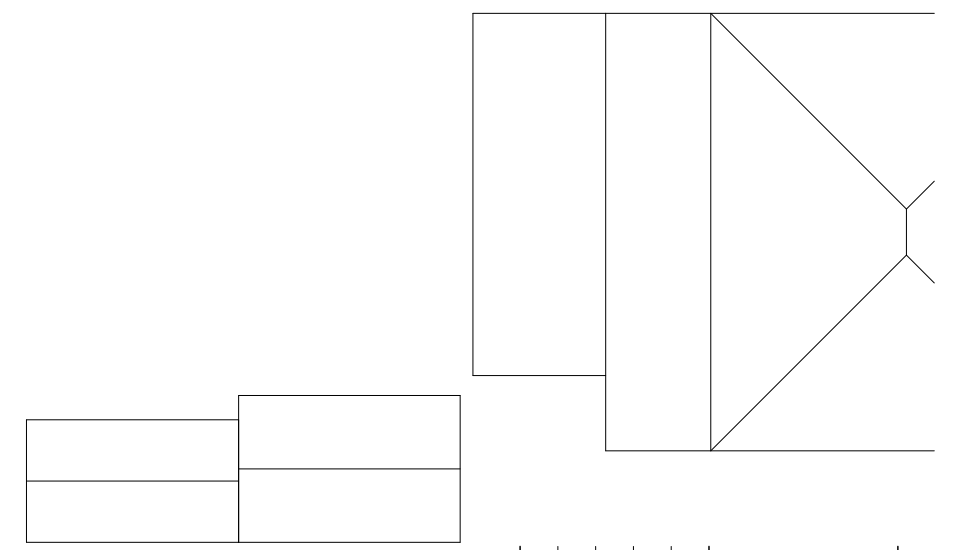
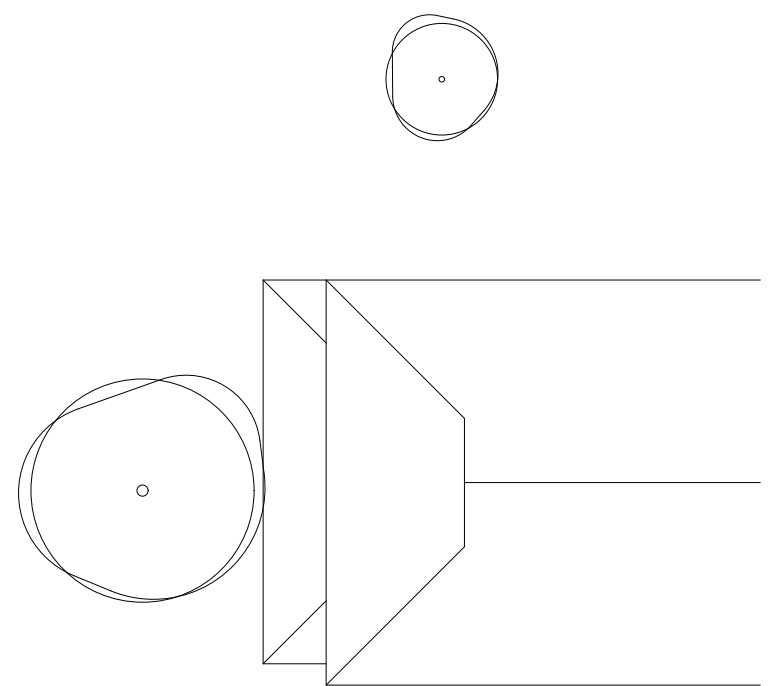
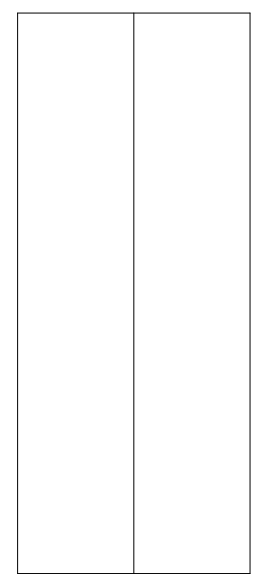
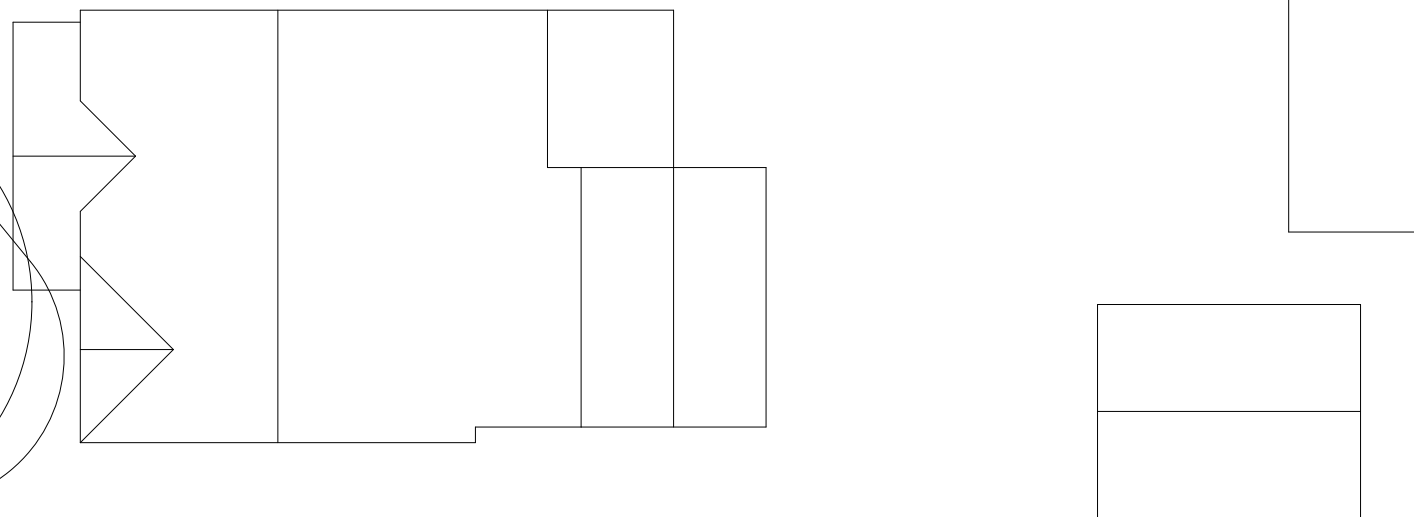
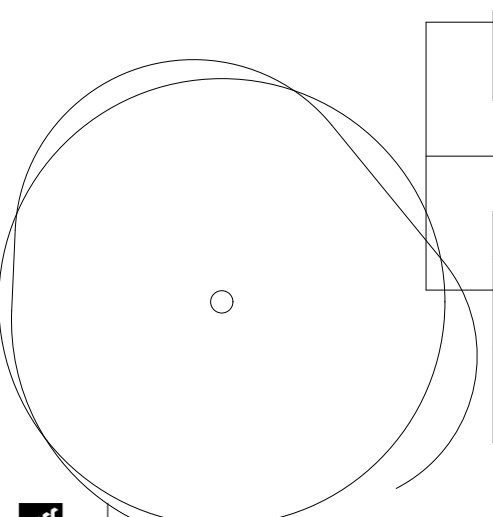

L
675m²

15
dw/ha net

48%
site cover

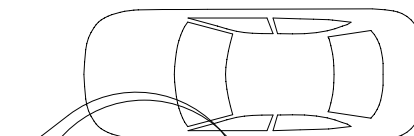
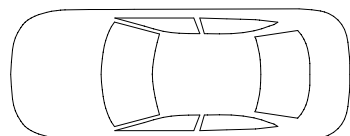

LARGE SITE: **business as usual** floor plan

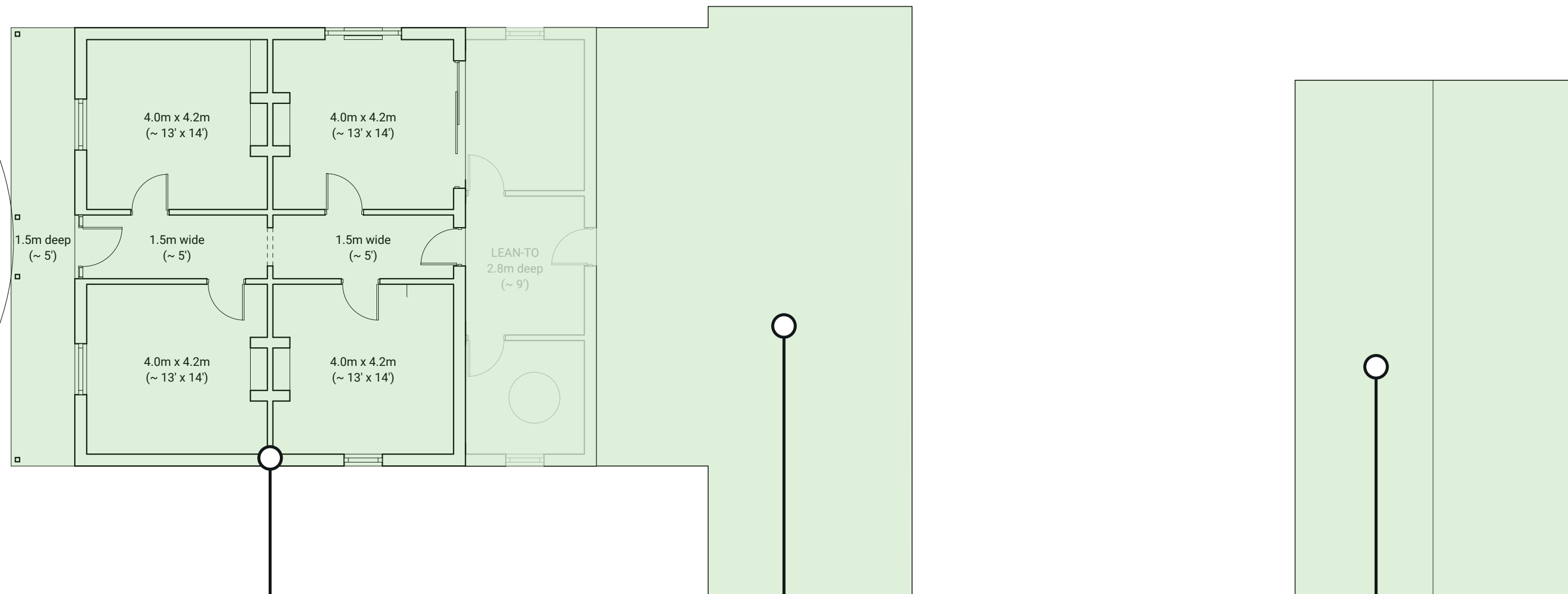

ORIGINAL HOUSE

EXTENSION

GARAGE / SHED

L
675m²

15
dw/ha net

48%
site cover

45
dw/ha net

37%
site cover

LARGE SITE: potential cohousing accommodation floor plan

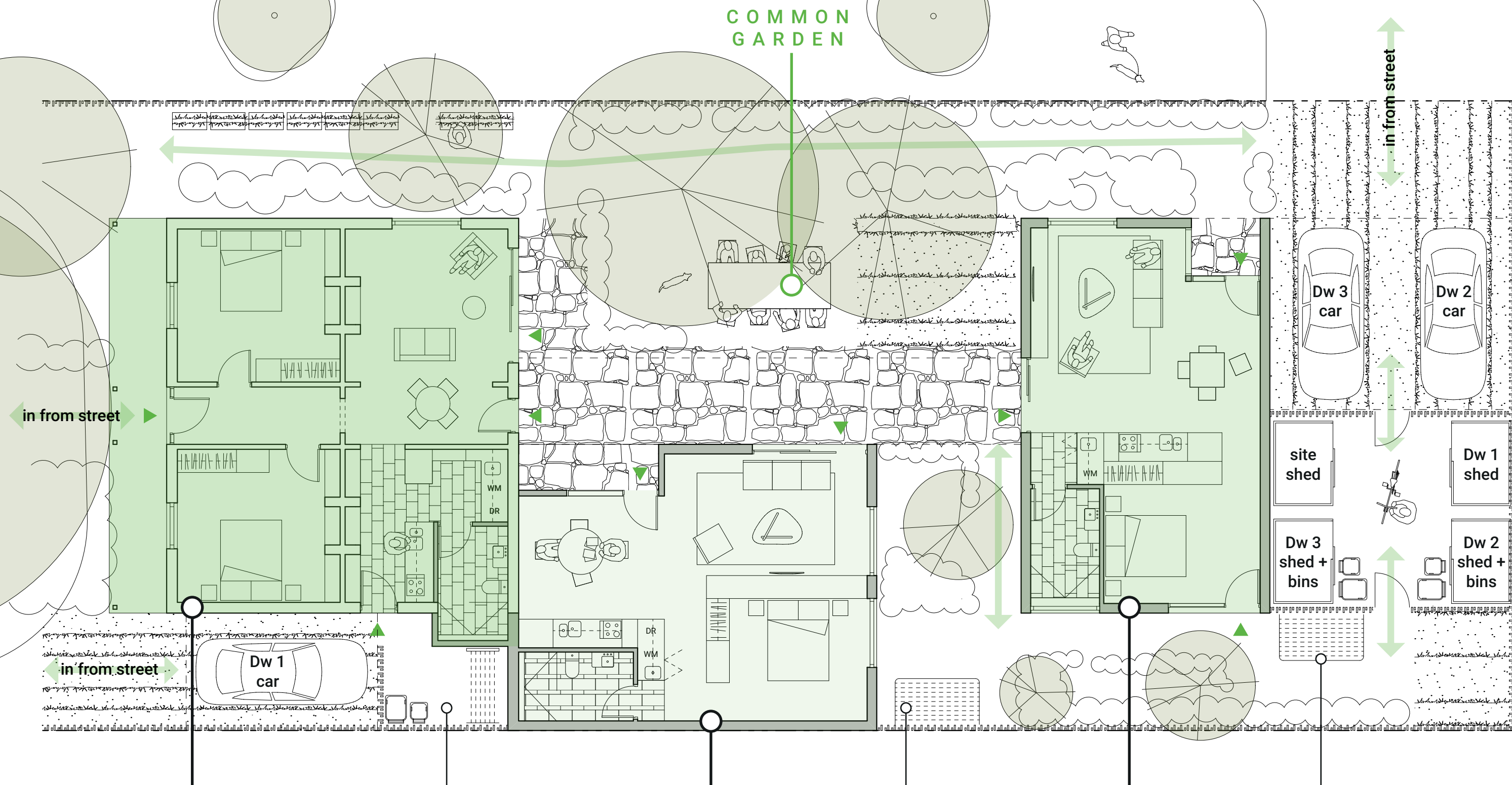

COMMON GARDEN

in from street

in from street

in from street

Dw 1 car

Dw 3 car

Dw 2 car

site shed

Dw 1 shed

Dw 3 shed + bins

Dw 2 shed + bins

DWELLING 1
(97m² in existing house:
2 bedrooms)

Dwelling 1
bins + washing line

DWELLING 2
(72m² in addition:
1 bedroom)

Dwelling 2
washing line

DWELLING 3
(67m² in backyard dwelling:
1 bedroom)

Dwelling 3
washing line

XL
920m²

11
dw/ha net

37%
site cover

EXTRA LARGE SITE: business as usual site layout

S
T
R
E
E
T

L
A
N
E

18.29m

50.29m

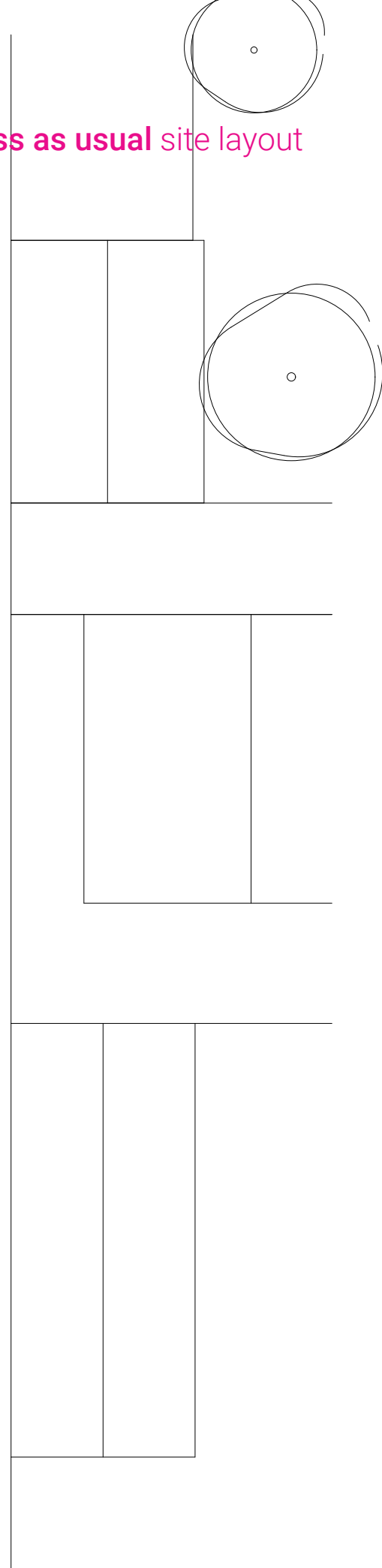
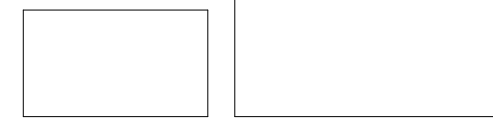
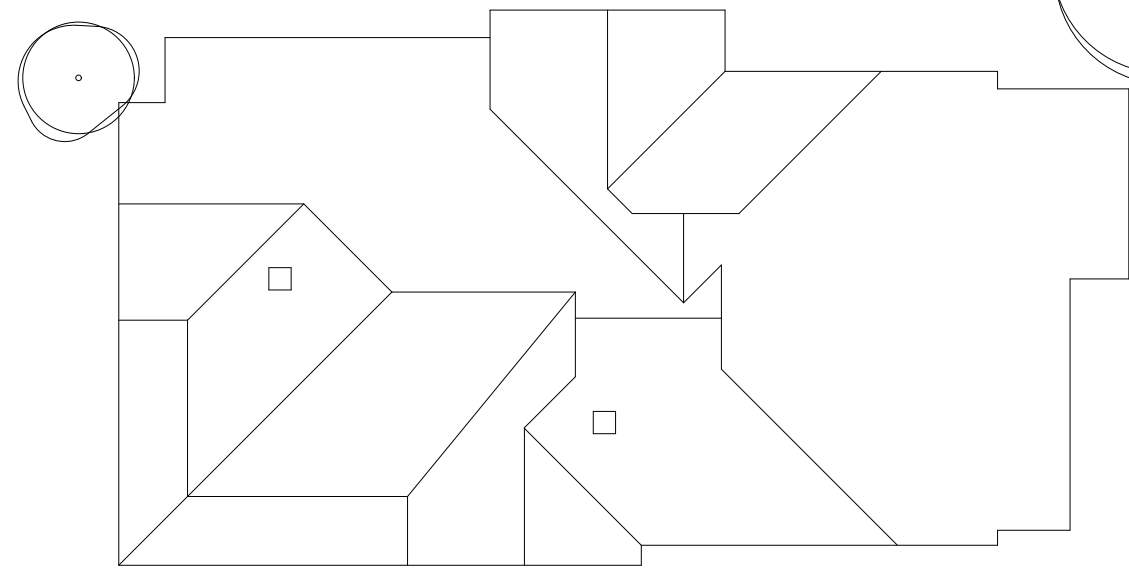
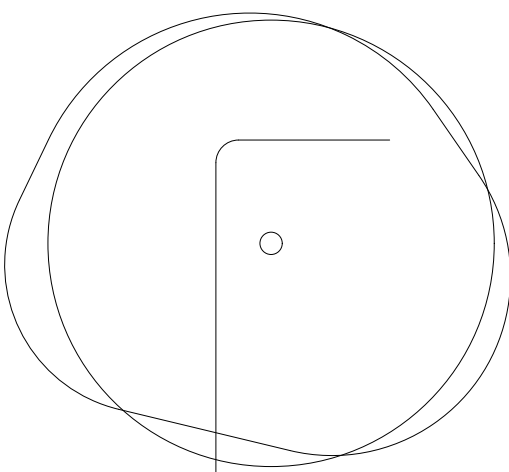

XL
920m²

11
dw/ha net

37%
site cover

33
dw/ha net

38%
site cover

EXTRA LARGE SITE: potential **cohousing accommodation** site layout

S
T
R
E
E
T

L
A
N
E

18.29m

50.29m

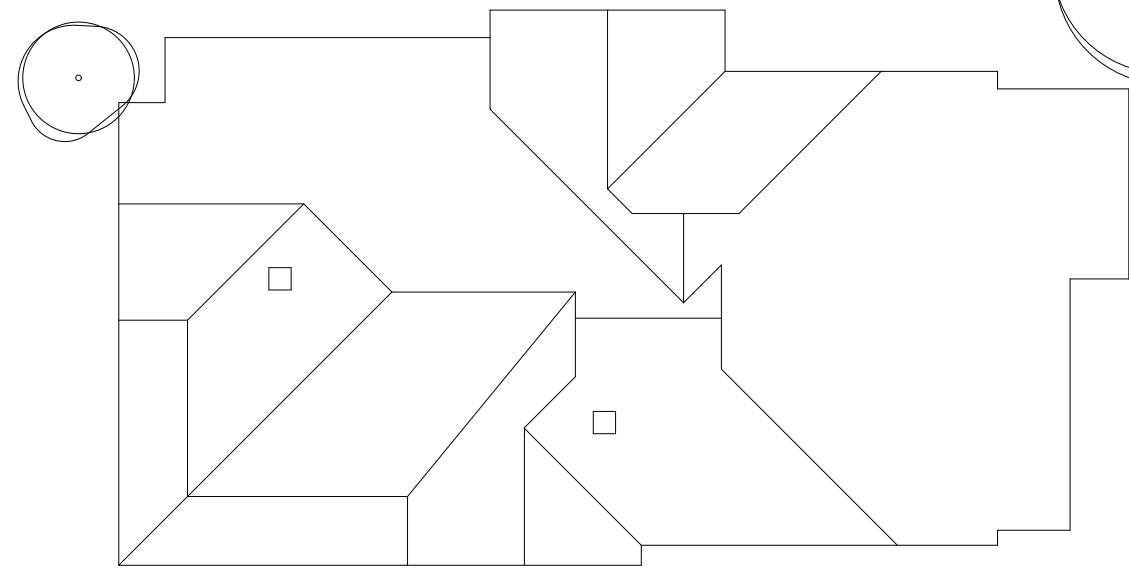
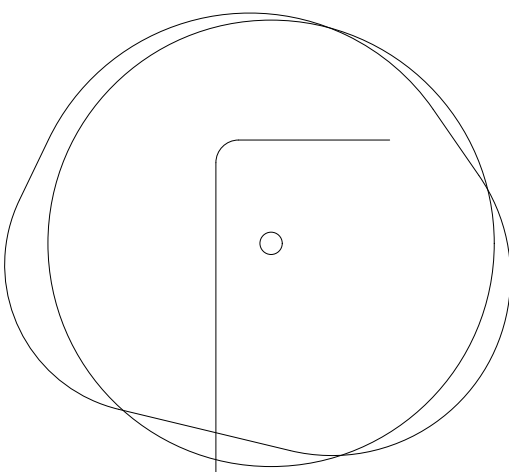

N

1:200 on A3

0 5 10m

XL
920m²

11
dw/ha net

37%
site cover

EXTRA LARGE SITE: **business as usual** floor plan

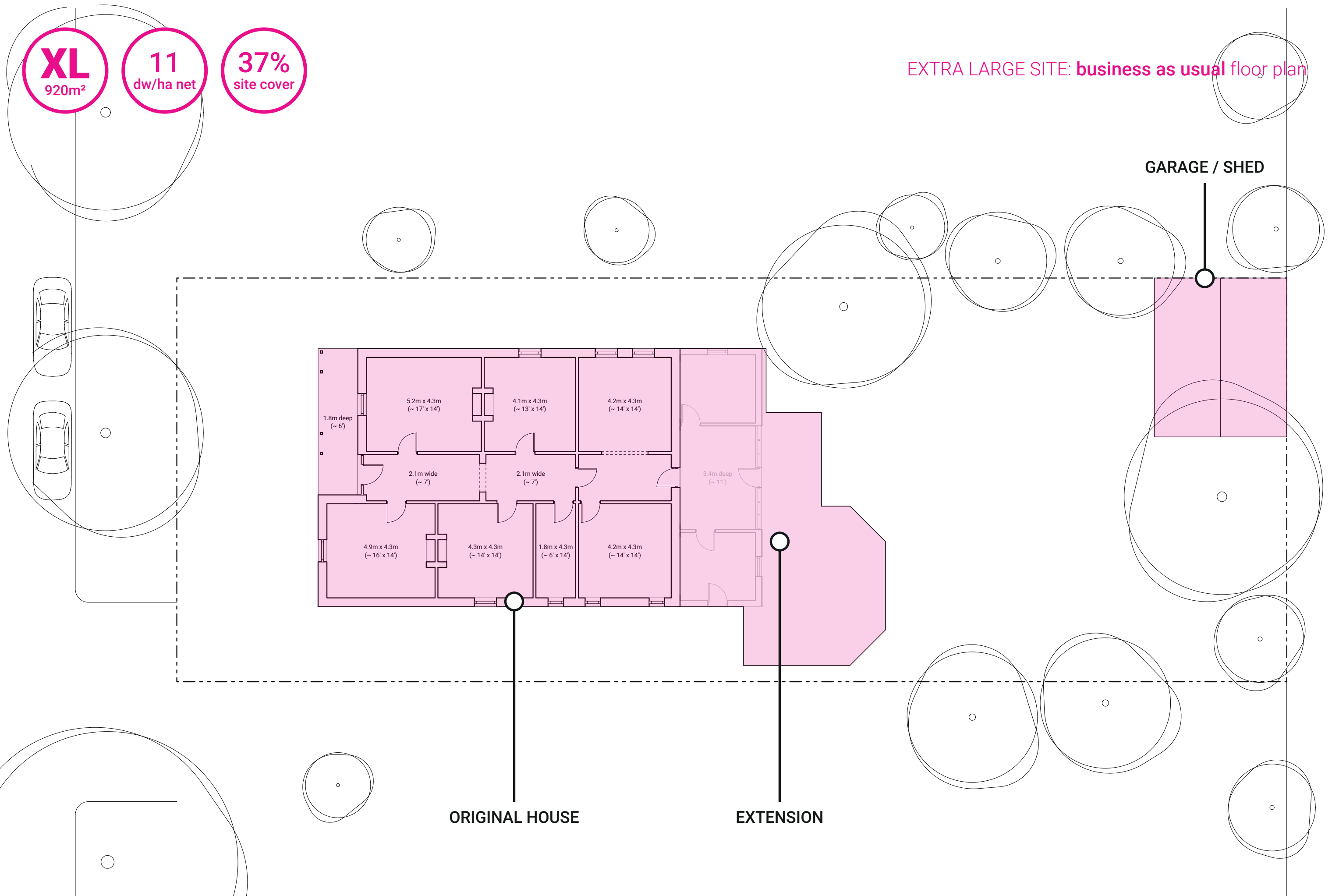

ORIGINAL HOUSE

EXTENSION

GARAGE / SHED

XL
920m²

11
dw/ha net

37%
site cover

33
dw/ha net

38%
site cover

EXTRA LARGE SITE: potential **cohousing accommodation** floor plan

DWELLING 1
(71m² in existing house, with
minor extension: 1 bedroom)

**COMMON
GARDEN**

washing line

bins

shed

3 x cars
under carport

in from street

in from lane

in from street

1 x additional
car park or garden

1 x additional
car park or garden

DWELLING 2
(67m² in existing house:
1 bedroom)

COMMON HOUSE
(103m²: shared facilities: study/guest bedroom,
bathroom, kitchen, dining, living, laundry)

DWELLING 3
(53m² in backyard dwelling:
1 bedroom)